



TURNED



KL-F01

Air Purifier,
large space type

User's Manual



Read and SAVE THESE INSTRUCTIONS

Thank you for purchasing Air Purifier
Large space type “KL-F01”
Please read this owner’s manual before you start using this appliance.
Read “Quick Start Guide” for the initial set up.

	Introduction	
The Flow of Use	3	
Safety Precautions	4	
Before Use	6	
	How to use	
Name of Each Parts	7	
How to use	8	
	Care & Troubleshooting	
How to Care and Maintain	11	
Trouble Shooting.....	14	
	Specifications	
Specifications	15	



The photocatalyst technology is applied to this large space type Air Purifier
 This product will bring you comfortable "noiseless space "



Photocatalytic technology reduces a variety of odors

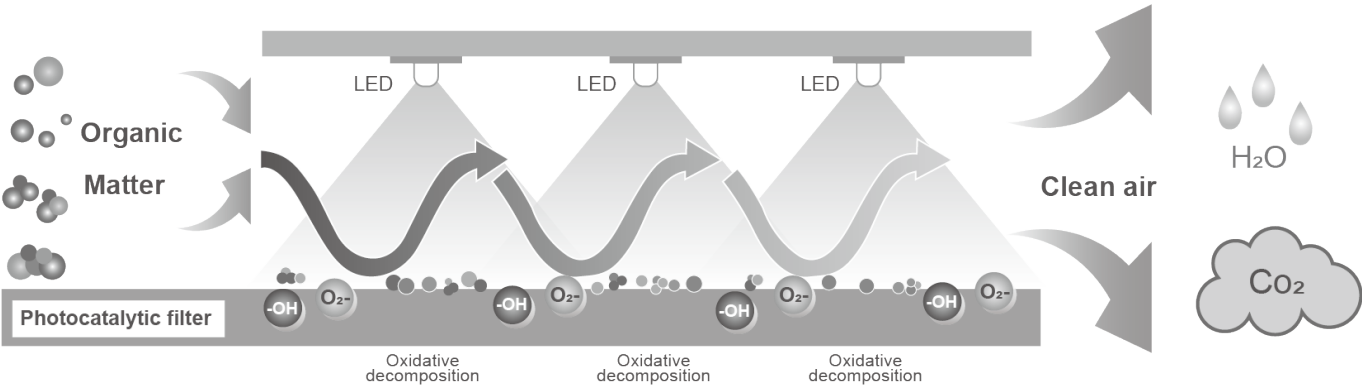

? What is "photocatalytic technology"? _____

When a photocatalytically active material is irradiated with light, it has a strong oxidizing power. This strong oxidizing capability of the photocatalyst can be used to reduce pollutants in the air.

The Flow of Use

1 ▾

How to Install

See Quick Start Guide ▶



2 ▾

Getting started

p.7 ▶

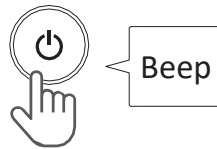

Just press the Power Button.

3 ▾

Use it

P.8 – P.10 or
See Quick Start Guide ▶

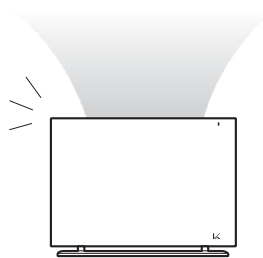

Pick the right place and scene for use,
You can make your own comfortable space.

4 ▾

How to turn off

P.9 ▶

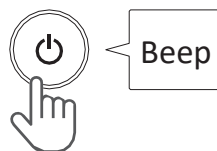

Press the Power Button.

Safety Precautions

Please make sure to follow these instructions.

Before using this product, be sure to read this "Safety Precautions" section.

The following information is provided to ensure the correct and safe use of this product.

- Notation of this item



WARNING Content that may cause fire, electric shock, or injury, resulting in death or serious injury.



CAUTION Contents that may cause burns or other minor injuries, or damage to the product, fire, or electric shock.



Prohibited actions



Actions that must be taken



Warning



- Only use your air purifier as described in this manual.
- Do not damage the power cord.
 - Do not modify, forcibly bend, pull, or twist.
 - Do not put heavy objects on it or let them get caught in it.
- Never place the cord near any heat source.
- Do not cover the cord with a rug, carpet, or other covering. Do not place the cord under furniture or appliances.
- Do not plug or unplug the power supply with wet hands.
- No overloading sockets.
- Do not use the product if the plug is loose.
- Do not disassemble, modify, or repair the main unit or the photocatalytic filter. Also, do not disassemble the photocatalyst filter when it's cleaning.
- Do not allow fine metal objects (pins, wires, etc.) to enter the inlet or outlet. ✘ When an object enters the air suction vent, the fan automatically stops and the power lamp and flash and beeps.
In this case, please contact your distributor. (→Page 13)
- Never place in water or liquid. Never pour water or liquid on it.
 - If liquid or foreign matter gets inside, turn off the power, unplug the power cord from the outlet, and contact your distributor.
- Do not wipe with oil, alcohol, benzene, thinner, or spray with hair spray or insecticide.
 - If it stays, wipe it off.
- Do not use in the range of the reach of infants.
- Do not use in a particular environment such as a factory and where salt damage occurs and where corrosive gas is generated etc.
- Do not use your air purifier outdoors.



- Use a 120V household AC outlet. / Use a household AC outlet.
- Insert the power plug firmly into the back of the outlet.
- Keep air purifier near the outlet it is plugged into.
- Keep the cord out of areas where people walk often. Place the cord where it will not be tripped over.
- Regularly remove dust from the power plug and AC adapter connection.
- Always unplug the power supply before cleaning.
- When lightning strikes, turn off the power and unplug it from the outlet.
- If you notice a burning smell or unusual noise during use, turn off the power, unplug the power cord from the outlet, and contact your distributor.

Caution.



- Do not use in the following places.
 - Close to combustible materials such as curtains and clothing.
 - Bathrooms and other places subject to water or high humidity
 - Places where oil components, such as cooking oil, are floating.
 - Places subject to severe vibration
 - Places where sprays and chemicals are used
 - Locations with flammable/explosive gases
 - Places exposed to direct sunlight or extreme high or low temperatures

- Do not place any objects on top of the product. Do not place heating or cooling appliance near the product, and do not let expose the product to fire.
- Do not operate the unit with the filter removed.
- Do not use this product in a place where it will be exposed to steam from humidifiers. Also, do not let the product suck in steam directly. This may reduce the life of the filter.
- Do not place the product in a place where it will be exposed to the strong air flow of an air conditioner or heater, or near a window.
- Do not subject the product to strong impact by stepping on it or dropping it.
- If the unit becomes hot during use, do not touch the unit.
- Do not block the inlet or outlet when the power is on and also during operation.
- Do not use this product in areas where smoke emitting insecticides or deodorants spray are used.
- Do not blow cigarette smoke into the inlet.
- The top board is made of natural bamboo, so be careful of the thorns.
- This appliance can be used by children aged from 8 years and above and persons with reduced physical, sensory or mental capabilities or lack of experience and knowledge if they have been given supervision or instruction concerning use of the appliance in a safe way and understand the hazards involved
- Children being supervised not to play with the appliance.
- Cleaning and user maintenance shall not be made by children without supervision.



- If you smell sour odor, set the air volume to "LOW" or "SILENT".
- Grasp plug and remove from the receptacle or other outlet device. Do not unplug by pulling on cord.
- When planning not to use for a long period of time, unplug the power cord from the power outlet.
- This product is not a substitute for ventilation. Ventilate frequently when this product is being used with combustible appliances.
- When disinfecting a room with chemicals such as smoke-based insecticides, turn off the power and move the unit or cover it with a sheet to prevent the chemicals from sticking to the product.
After disinfecting the room with chemicals, be sure to ventilate the room well before resuming operation.
- At the disposal of this product, please follow the instructions of the local community rule and dispose of it properly.

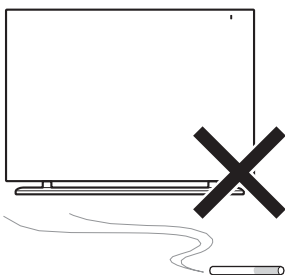

This appliance is a device that collects odor components in the entire room. In an environment where strong odors are generated*¹ or in an environment where sprays containing fluorine resin or silicone are used*², odors and insulation adhere to the photocatalyst filter, and the effect is reduced. In such cases, please clean the photocatalyst filter. (→Page12)

*¹ Air freshener, aroma oil, tobacco, using cooking grill, etc.

*² Cosmetics, hair care agents (hair mousse, hair treatment, split coat, etc.), antiperspirants, antistatic agents, waterproof sprays, glass cleaners, waxes, chemical wiping cloths, etc.

Before Use

● Installation location

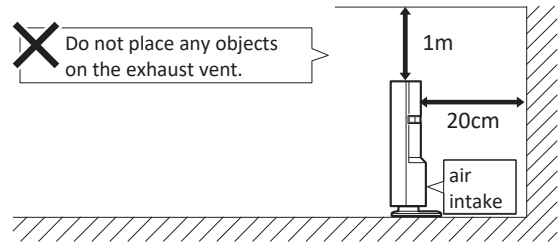
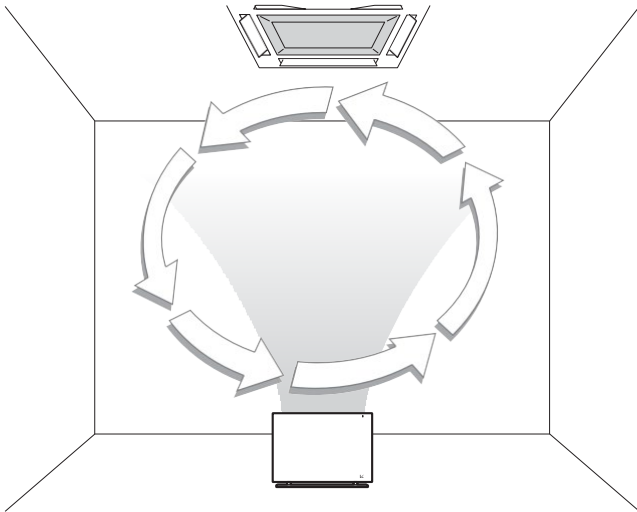

Place the unit 20 cm away from the wall. Do not place any objects on top of the unit. When it is placed on the other side of the air conditioner, it increases the circulation effect, reduces unevenness in room temperature during heating and cooling, and increases the deodorizing effect.

※ The usage scene is a reference image based on the results of our experiments.

● Attaching a Fall Prevention Band

To reduce the risk of injury or other harm caused by tipping over or falling due to an earthquake or any type of vibration, take measures to prevent tipping over or falling.

(If necessary, secure the unit with the supplied fall prevention band.)

※The fall prevention band is not guaranteed to be effective against all earthquakes or any type of vibrations.

※Depending on the strength of the board and wall which the fall prevention band is attached to may greatly reduce the effectiveness of the fall prevention and fall prevention. In this case, please reinforce it appropriately.

※This product may fall backward. Do not push or lift the product after it has been placed and secured close to a wall.

※When moving the unit, unplug the power plug from the power outlet, remove the fall prevention band, and then move the unit by holding the handle on the back.

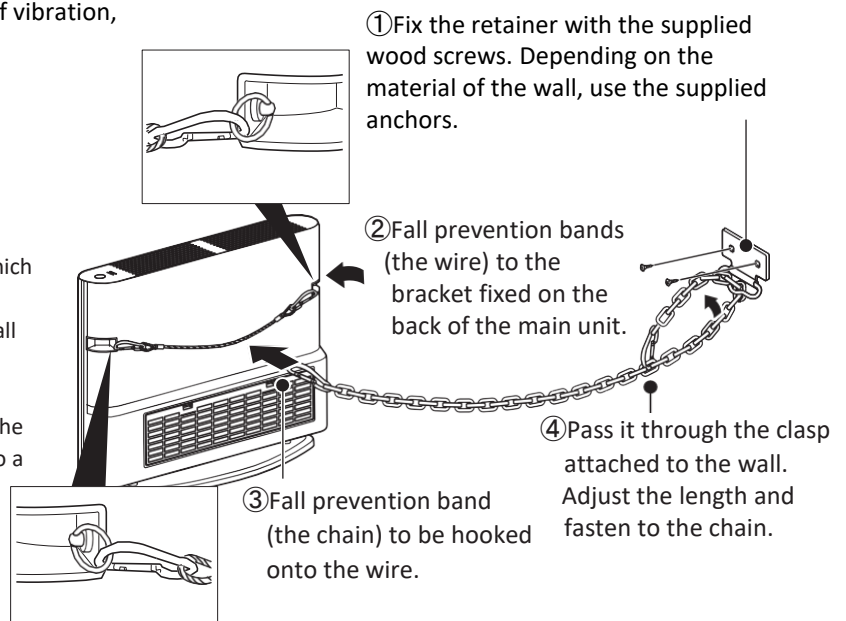

! Precautions for Installation

- Do not use the product in a place where it will be exposed to steam from a humidifier. Also, do not allow the product to take in steam directly. This will reduce the life of the filter and cause it to malfunction.
- Keep away from direct sunlight. This may cause deformation, alteration, or discoloration.
- Do not place near air conditioners, heaters, or windows. This may cause deformation, alteration, discoloration, or malfunction of the sensor.
- If TV noise occurs, or the radio clock does not set correctly, move it as far away as possible from the TV and radio clock.
- In environments where strong odors occur, it is recommended to use this product with proper ventilation of the space.

Name of Each Parts

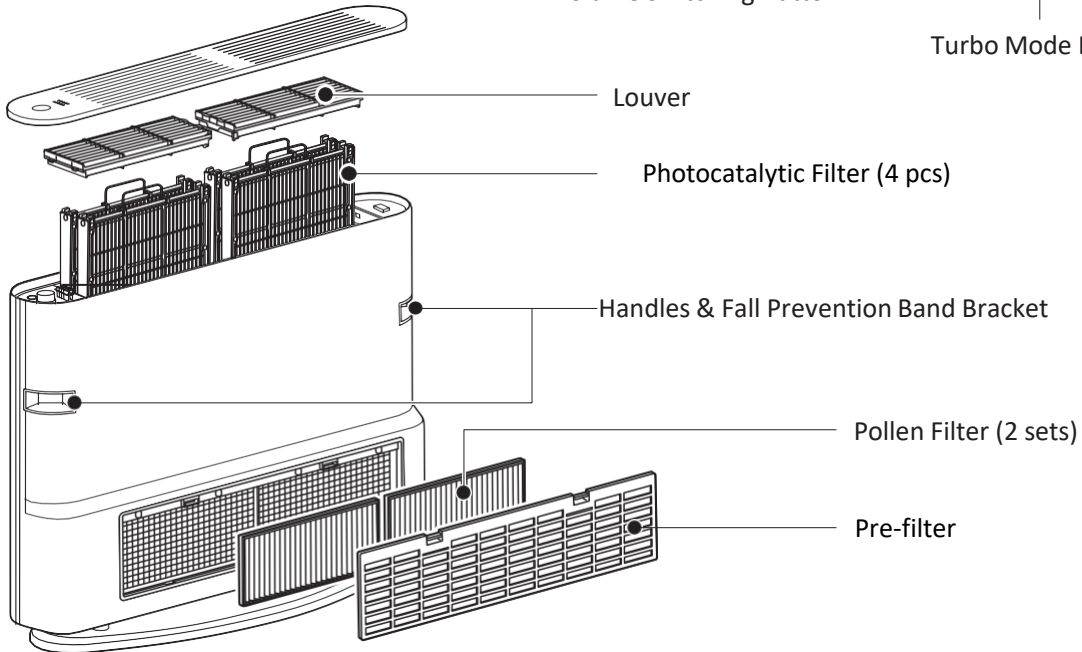
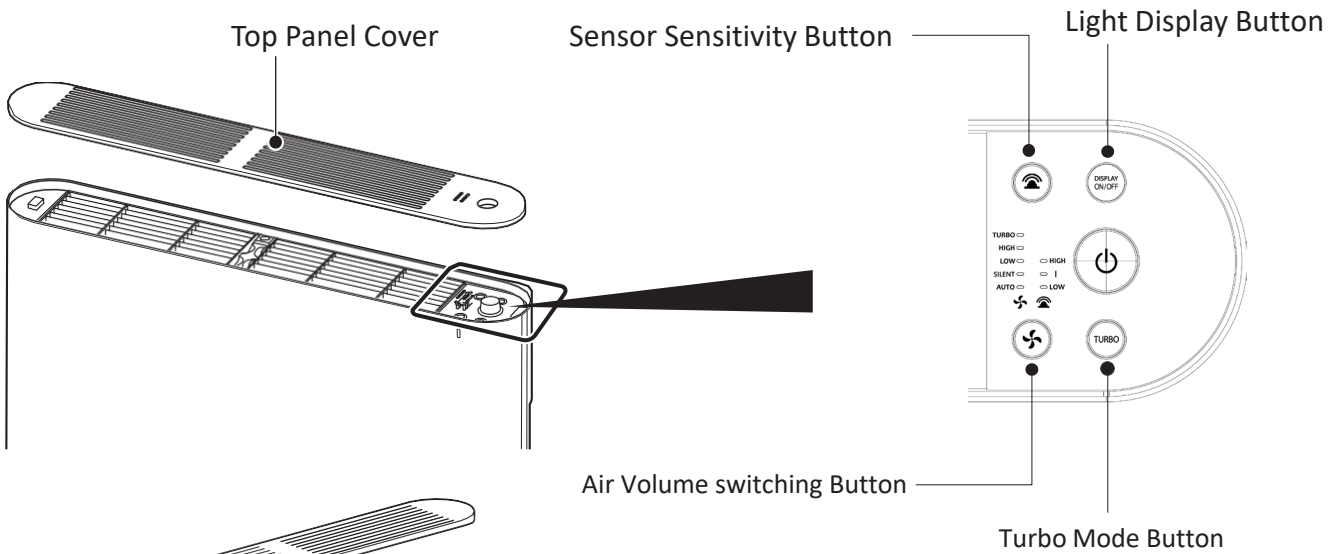
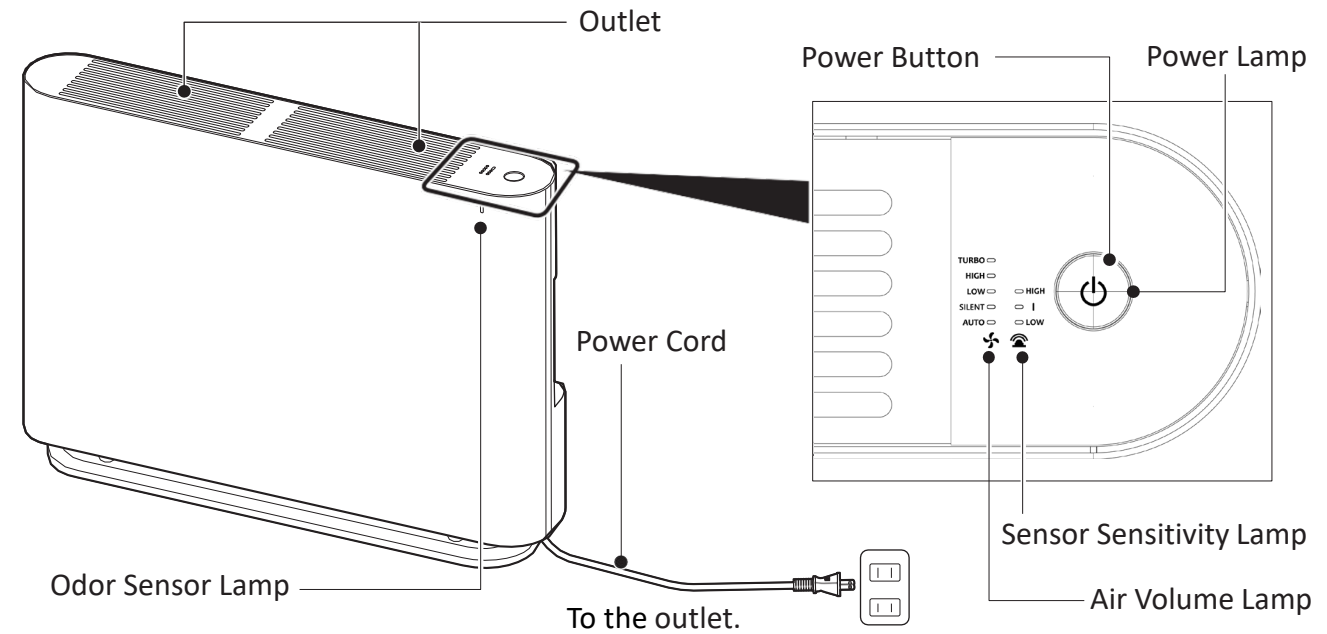

How to use

1 Turn on the power

Press the Power Button.

Power Lamp lights up.

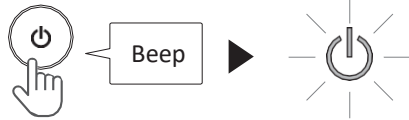

The levels of the odor in the room is displayed in three colors by the odor sensor.

(In 3 stages: Green, Yellow and Red)

When the air volume is set to "Auto", the air volume is automatically switched according to the odor intensity detected.

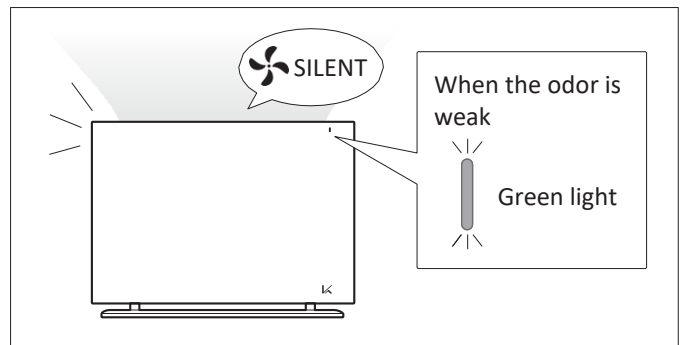
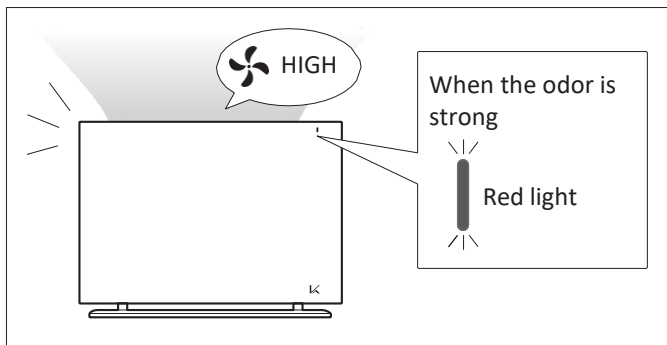
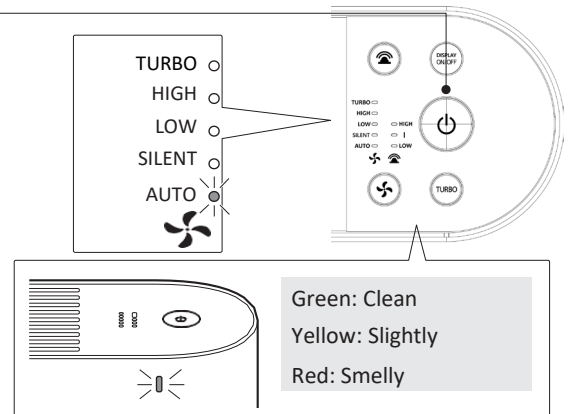

The odor sensitivity is adjusted with the Sensor Sensitivity Button. When the sensor sensitivity is set, the air volume will be "Auto". When odor is strong or want to use a certain constant air volume, set the air volume with the Air Volume Button (→ Page 9)

Memo

- The sensor sensitivity and air volume level setting will be saved, when turned off.
- When you go to sleep, you can turn off all lights except the power light by pressing the light display button. (Press once more to turn on.)

• Removing and placing the Top panel cover

The sensor sensitivity button, air flow volume button, light display button, and turbo mode button are located on the top of the main unit. To operate them, remove the Top panel cover.

Press the left end of the Top panel cover (the opposite of the power button) to lift the Top panel cover and remove it.

※ This is natural bamboo, so be careful of the thorns.

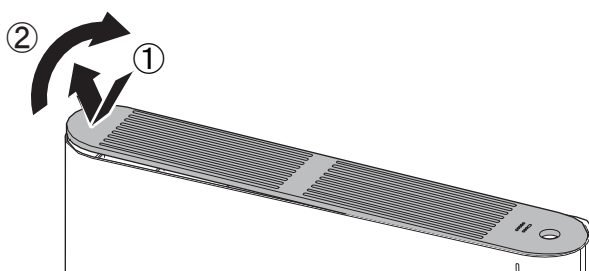

Install with attention to the direction of the power switch hole, and press down on the left end (the opposite side of the power switch).

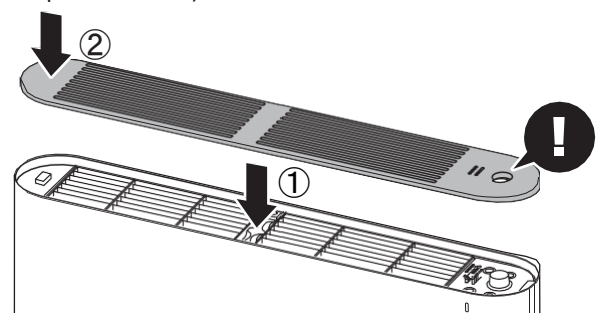

2 Set the sensor sensitivity (when using with the airflow set to "Auto")

At first, it is set to "High".

The sensitivity setting of the odor sensor varies depending on where it's placed and environment around the product. Refer to "Recommended mode settings for various locations" for the proper settings. (→ page 10)

Remove the Top panel cover.

※This is natural bamboo, so be careful of the thorns.

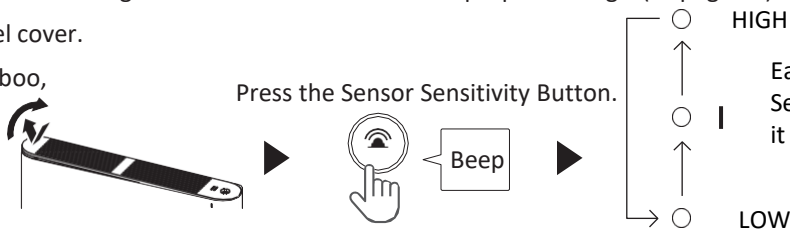

Each time the Sensor Sensitivity Button is pressed, it changes.

Memo

Sensor sensitivity is applied when air flow volume is set to "Auto". The air flow volume is set to other mode, it operates at a constant air flow regardless of sensor sensitivity level. (→page 9)

3 Adjust the air volume

Initially, it is set to "Auto". When the air volume is set to "HIGH", "LOW", "SILENT", or "TURBO", continuous operation is performed at the set air volume regardless of the sensitivity of the odor sensor.

Remove the Top panel cover.

※This is natural bamboo, so be careful of the thorns.

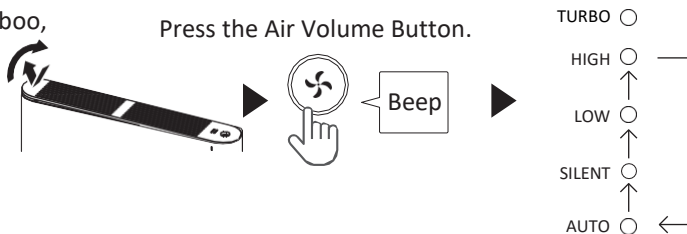

Press the Air Volume Switching Button to change the mode. To change to turbo mode, press the Turbo Mode Button. (→page 10)

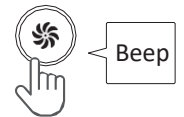

Memo

When the air volume is set to "Auto," the sensor detects room odors and automatically switches the air volume mode.

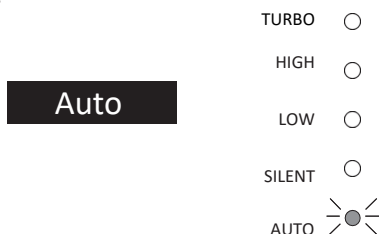

Odor sensor color	Air Volume
Green	SILENT
Yellow	LOW
Red	HIGH

4 Power Off

Press the Power Button.

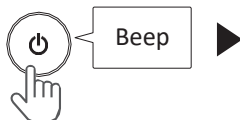

Power off.

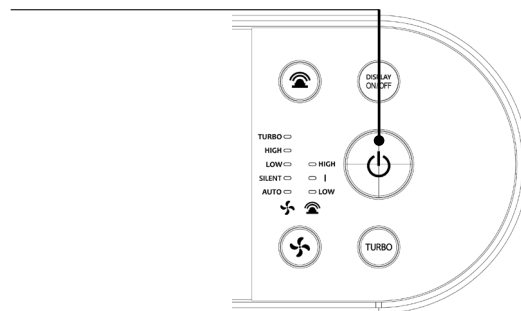

Memo

When you do not use this appliance for a long time, unplug the power plug from the outlet.

After the power plug is unplugged from the outlet, the "sensor sensitivity" and "air volume" return to the default setting.

How to Use (continued)

- When you want to sterilize/deodorize quickly (using turbo mode) Turbo mode, for 30 minutes It will then switch to automatic mode.

Using the turbo mode, the room can be deodorized faster than in normal operation.

If you want to change the turbo mode to the normal mode within 30 minutes, press the Air Volume Button to change back to the automatic mode.

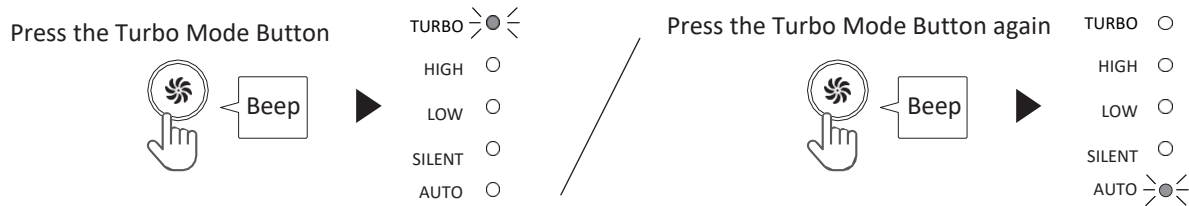

This function can be useful for

- Sudden Visitors
- Opening Store Preparation
- Standard air changes
- Event Openings/ beginning of work

Approximate operation time in turbo mode

- approx. 31 m² --- 10 min.
- approx. 62 m² --- 20 min.
- approx. 93 m² --- 30 min.

- Recommended mode settings for various locations * The setting levels for each room are based on our experiment results.

Use this product efficiently by changing the sensor sensitivity and air volume settings.

Usage Scene	Sensor Sensitivity	Air volume
Waiting room / Entrance	HIGH	HIGH
Conference Room	HIGH	AUTO
Classroom	HIGH	AUTO
Gymnasium / Warehouse	HIGH	SILENT

How to Care and Maintain

Please keep the appliance front panel and vent area clean. In particular around the air outlet where dust and dirt stains may build up, ensure the air outlet surrounding areas are cleaned on a regular basis.

If you want to know the recommended frequency of maintenance, see "Guide for caring ". (→page 13)

● Main unit and air vent

Wipe off stains with a dry soft cloth.

Wipe the surface without pressing hard on top of the Air outlet.

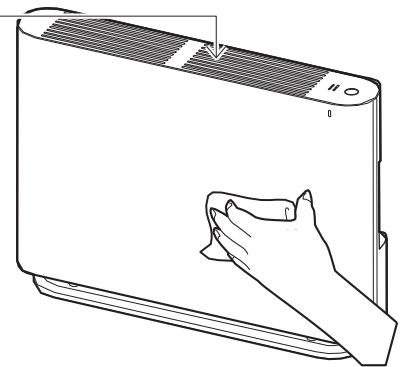

● Cleaning the Pre-filter and Pollen filter (air vent)

- 1** Turn off the power and remove the Pre-filter.

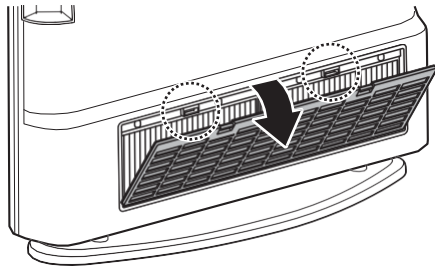

- 2** Remove dust from the Pre-filter with a vacuum cleaner.

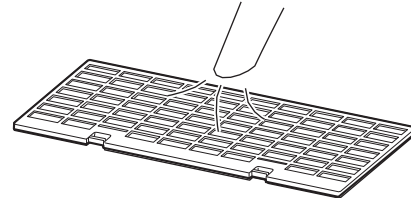

※Do not scratch the surface of the filter. If the filter is too dirty, wash it with neutral detergent and dry it well.

- 3** Pull down the filter Tab.
Remove the Pollen filters (2 pcs).

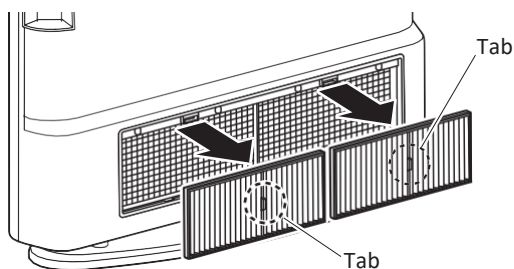

- 4** Remove dust from the pollen filter with a vacuum cleaner.

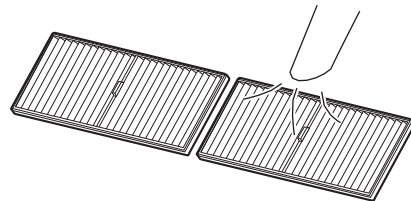

※Do not scratch the surface of the filter. If the filter is too dirty, wash it with neutral detergent and dry it well.

- 5** Place the Pollen filter (2 pcs) with the Tabs facing towards you.

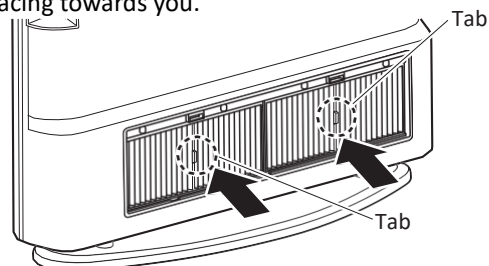

- 7** Attach the pre-filter.

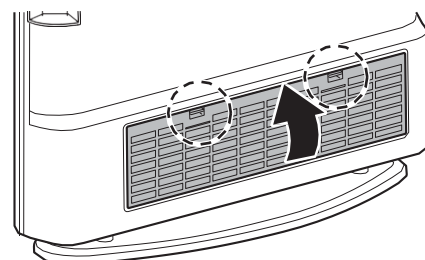

How to Care and Maintain(continued)

● Cleaning the Photocatalyst filter

Rinse the dust on the surface of the Photocatalyst filter.
Rinse all 4 filters at once.

- 1** Turn off the power.
Press the end to remove the Top panel cover.

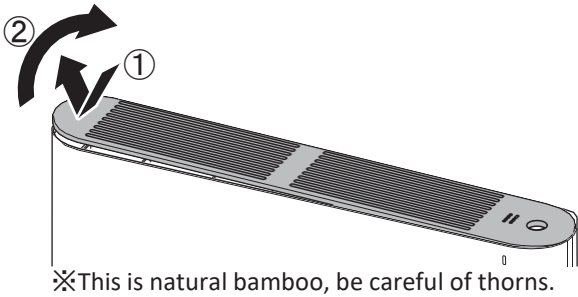

- 2** Remove the louvers.

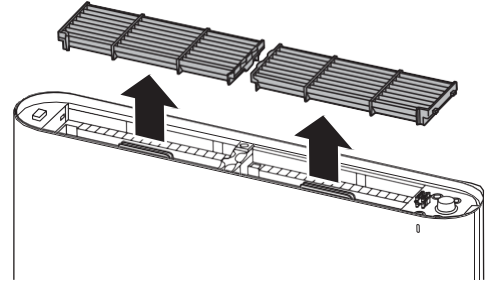

- 3** Remove the Photocatalytic filters (4 pcs)

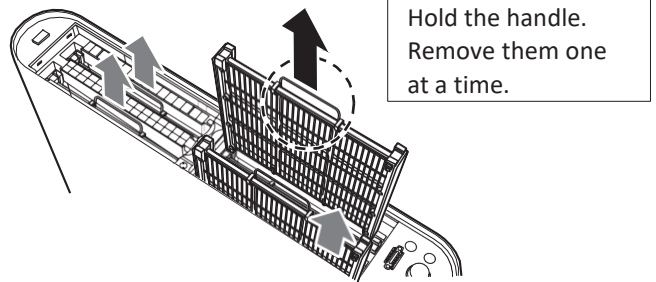
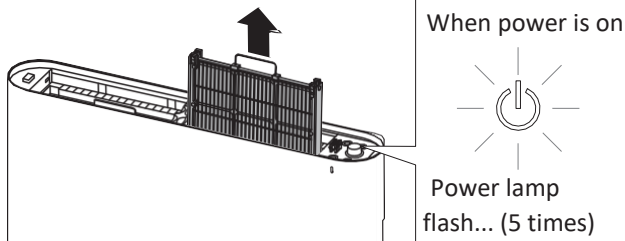

- 4** Soak the filter for approx. 10 hours.

Do not use detergent or soap! Do not disassemble the Photocatalytic filter!

Only to use water or lukewarm water

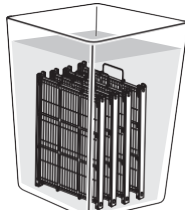

More than 10cm

* Use a 45L dust box as a container, it will be a best fit.

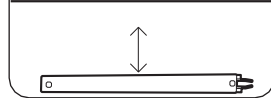

Do not scrub the filter

The photocatalyst may come off.

- 5** Air dry in the sun

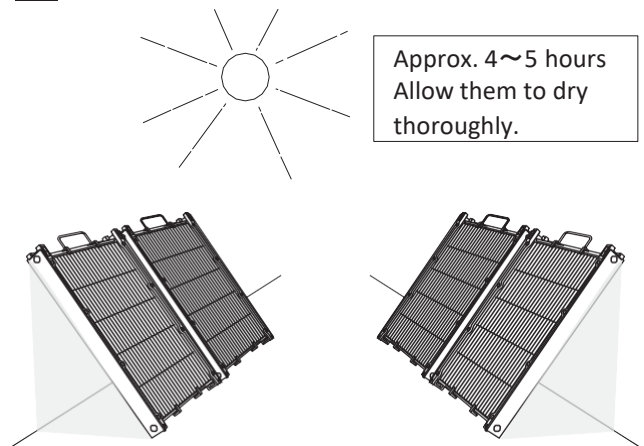

- 6** Put the photocatalytic filters (4 pcs)

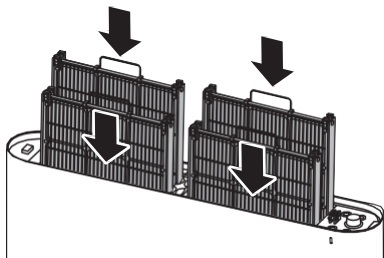

- 7** Put the louvers (2pcs) and the Top panel cover and turn on the power.

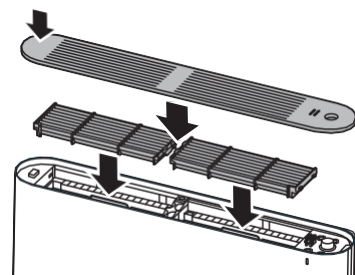

Attention.

- The container in which the Photocatalytic filter is soaked should be free from detergent, soap, chemicals, and oil.
- If the louvers are not installed correctly, the power lamp will blink and you will need to reinstall them.

How to Care and Maintain (continued)

- Guide for caring

※ Our recommended standard below.

The frequency of the care depends on the usage environment.

Locations	Cleaning Instructions		
	Pre-filter	Pollen filter (2 filters at once)	Photocatalytic filter (4 filters of once)
Waiting room / Entrance	Once every 2 months		Once every 3 months
Conference Room	Once every 3 months		Once every 4 months
Classroom	Once every 2 months		Once every 3 months
Gymnasium / Warehouse	Once every 3 months		Once every 4 months

 When foreign matters enter in the fan, the fan will automatically stop.

- When the fan stops automatically.

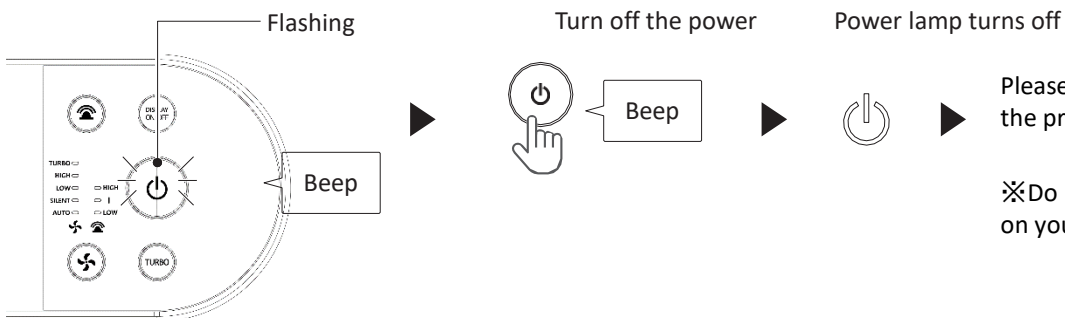

Please contact the dealer you purchased the product or contact your distributor.

※Do not try to part the product and fix on your own.

- It automatically turns off when there is an impact from outside or tilts.

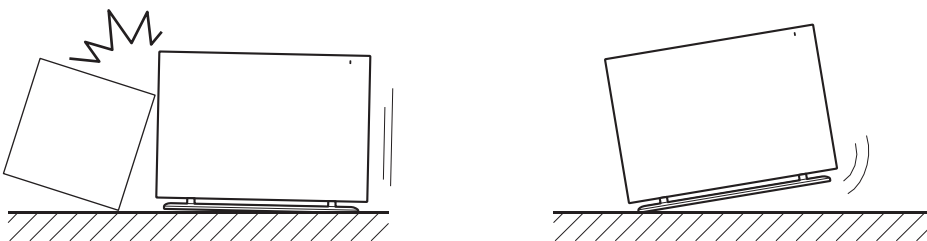

Trouble shooting

■ Power does not turn on / does not work

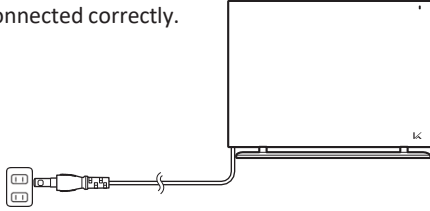
Please check	Possible solutions
Is power plug inserted into the outlet correctly?	Make sure the following is connected correctly. 
Is your area during power outage?	Please wait for electricity supply to resume.
Is the electrical circuit breaker at the location turned ON?	Turn back on the electrical circuit breaker.

■ Regarding operation lights and operation

In such cases	Please check	Measures
No lamps are ON except Power light	Is the light display turned off?	Press the Light Display Button and check the lights.
Beeping and the Power lamp flashing	Are Louvers correctly Installed?	Be sure that the louvers are set correctly.
No air flow. Air flow does not change despite adjusting volume. Air volume is weaker than purchase	The Pre-filter / Pollen filter Are they dirty?	This may affect the performance of the purifier. Clean the Pre-filter / Pollen filter. (→page 11)
	Is the air volume set to a mode other than "Auto"?	<ul style="list-style-type: none"> ● Please confirm "How to use".(→Page9) ● Press the "Air Volume" Button and check that the operation mode can be changed.
The "air volume" changed without adjustment	Check the current air volume mode.	During automatic mode, when the odor is detected, the air volume changes automatically. Please refer to "How to use". (→Page9)
The odor sensor does not indicate green.	Are the windows and doors in your room open?	In rooms with low airtightness, it may be difficult to return to green due to external odors and changes in temperature.
The odor sensor switches frequently.		It may respond to opening and closing doors and windows, and human movement. When it switches frequently, adjust the sensor sensitivity . (→Page8)
The odor sensor does not change color		When the odor sensor does not change from green, the air is clean. When the color of the sensor does not change even if you feel the odor, adjust the sensor sensitivity. (→Page8)

Trouble Shooting (continued)

■ Room odor cannot be reduced significantly / Odor comes from air outlet

Please check	Measures
Did you cause strong odors in your room, such as using grill or smoking?	If strong odor occurs, it takes time to reduce. Turn on the appliance for a short period will gradually reduce odor. In rooms with a large amount of smoking, the odor of cigarettes cannot be reduced significantly.
Is the sensor sensitivity "LOW" or the air volume "SILENT" or "LOW"?	<ul style="list-style-type: none"> ● When the air volume is switched to "HIGH", the odor-reducing function becomes "HIGH" regardless of the sensor sensitivity. ● Switching the sensor sensitivity to "HIGH" increases the sensitivity for the odor and improves the deodorizing effect. <p>< CAUTION > The sensor sensitivity is valid only when the air volume is set to "AUTO". When the air volume is set to "HIGH", "LOW", or "SILENT", the unit operates at the preset air volume regardless of the sensor sensitivity.</p>
Odor components such as pet odor, building material odors are being constantly generated. They cannot be reduced significantly.	It is not possible to reduce odors that are constantly being generated. Please use it in conjunction with space ventilation.
Long-term usage may reduce the odor-reducing effect.	<ul style="list-style-type: none"> ● Please clean the Photocatalytic filter when you feel that the odor-reducing effect has weakened. (→page 12)
If you smell a sour odor	<ul style="list-style-type: none"> ● Set the air volume to "Low" or "Quiet". (→page 9)

Specifications

Product name and model number	TURNED  KL-F01 Air Purifier, Floor type			
Method	Photocatalytic filter			
Power supply (rated input)	AC100V~240V 50-60Hz			
Applicable space (approximate)*1	Approx. 97m ² (1044ft ²)/30min			
Air volume mode	TURBO	HIGH	LOW	SILENT
Power consumption	135W	90W	65W	60W
Operating noise	62dBA	56 dBA	47dBA	36dBA
Operating temperature range	Above 0°C to below 40°C			
Drip-proof and waterproof specifications	Not supported.			
External dimensions	(W) 736mm x (H) 544mm x (D) 203mm			
Weight	Approx. 16 kg			
Power cord length	Approx. 1.8m			

● Dimension Drawing (mm)

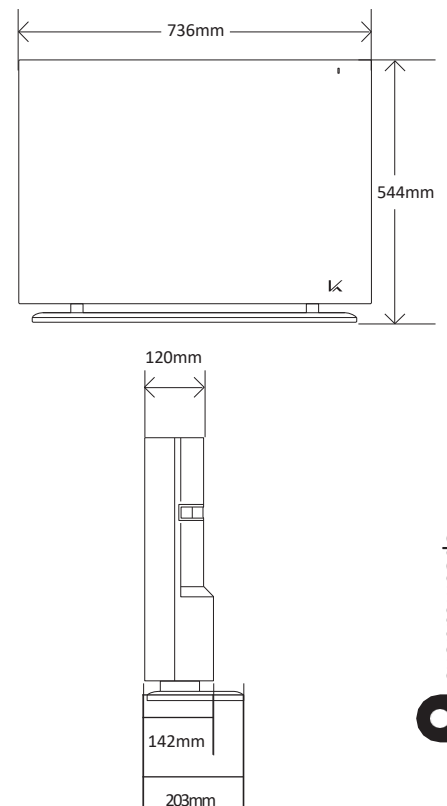

*1 According to generally accepted standard, when the appliance is used for the applicable floor area it can reduce odor to comfortable level in about 30 minutes. (Depending on the environment)



Kaltech Corporation

3-3-7 Bakuromachi, Chuo-Ku, Osaka 541-0059, Japan

FO1-tr ver.1.0

EN_KL-F01_User manual_E_v1.0_2309